

WALL MOUNTING DIGITAL THERMOSTATS WITH DISPLAY



PE - DETPNN006 10/10



Funzionamento Inverno / Estate
2 livelli di temperatura + antigelo

Winter and Summer mode
2 temperature levels + antifreeze

Fonctionnement Hiver ou Été
2 niveaux de température + antigel

Betrieb Winter oder Sommer
2 Temperaturstufen + Frostschutz

Funcionamiento Invierno / Verano
2 niveles de temperatura + antihielo

MODELLI/MODELS/MODELES/MODELLE/MODELOS:



L - N: 230V ac

INDEX

ENGLISH



TECHNICAL DATA	page	21
GENERAL VIEW AND KEY FUNCTIONS	page	22
INSTALLATION	page	23
USER INSTRUCTIONS	page	27
PROGRAMMABLE FUNCTIONS TO ADAPT TO THE TYPE OF INSTALLATION	page	30
RESET OPERATION	page	36
EVENTUAL FAULTS AND SOLUTIONS	page	37

WARNING

- Read this manual carefully before using the product because it contains important indications regarding safety, installation and use. Keep this manual available for further consultation.
- Installation and electric connection of the thermostat must be executed by qualified personnel and in conformity with the existing laws and regulations.
- If the display flashes the room temperature at 0 °C o +37.7 °C (+32 °F o +99.9 °F) it means that the **measured temperature is over the scale limit**.
- If the display flashes "- - - -" this means that the probe is not working, all thermoregulation activity is suspended.
- **3V dc model:** use only two stilo alkaline 1.5V batteries type AAA (LR03); fitting inappropriate batteries could lead to loss of the entered programming.
N.B.: this product has been tested and guarantees all its characteristics with DURACELL or ENERGIZER alkaline batteries.
- **230V ac model:** after installing and setting the thermostat, in case of absence of power supply the display switches off saving all the programmed settings effected, when power supply is reinstated, the display switches back on and the device returns to its normal functions.
- When required, wipe the thermostat with a slightly damp cloth.
- The manufacturer has the faculty to introduce all the technical and production changes which will be deemed necessary with no obligation of prior notice.

TECHNICAL DATA

EN

Power supply:	battery model 2 x 1,5V Alkaline ministilo type AAA (LR03); line voltage model 230V 50÷60Hz
Battery model life:	aprox. 2 years
Time of autonomy from the  flash indicating low battery:	1 month
Type of action, disconnection and device:	1/B/Electronic
Type of output:	relay with exchange contact NO/COM/NC no potential max 5 (3) A / 250V
Software:	Class A
Nominal pulse voltage:	4 kV
Connection to line voltage:	2 conductors (only for 230V~ ac models)
Load voltage:	2 or 3 conductors
Cables and terminals section:	1,5 mm ² ÷ 2,5 mm ²
Levels of Temperature:	COMFORT and NIGHT ECONOMY + antifreeze
Room temperature display field:	0 °C ÷ +37,7 °C / +32 °F ÷ +99,9 °F
Room temperature resolution:	0,1°C / 0,1°F
T set Temperature regulation field:	+5 °C ÷ +37,7 °C / +41.0 °F ÷ +99,9 °F (limitable)
Set temperature resolution:	0,1 °C / 0,1 °F
Antifreeze temperature:	+4 °C ÷ + 12 °C / 39.2 °F ÷ 53.6 °F (adjust/exclude)
Tolerance on temperature reading:	± 0,5 °C / ± 0,9 °F
Type of temperature regulation:	
- ON/OFF with differential	setting from 0,2 °C to 1,2°C / from 0,3 °F to 2,1 °F (default 0,5 °C / 0,9 °F)
- Proportional with control period	setting from 7 to 20 minutes (default 10 minutes)
Thermal gradient:	1°K / 15 min
Protection degree:	IP 30
Isolation class:	II 
Pollution degree:	normal
Running temperature limit:	0 °C ÷ +50 °C / +32 °F ÷ +122 °F
Storage temperature limit:	-10 °C ÷ +65 °C / +14 °F ÷ +149 °F
Norms of reference for EC branding:	LVD - EMC EN60730-1 EN60730-2-9

GENERAL VIEW AND KEY FUNCTIONS

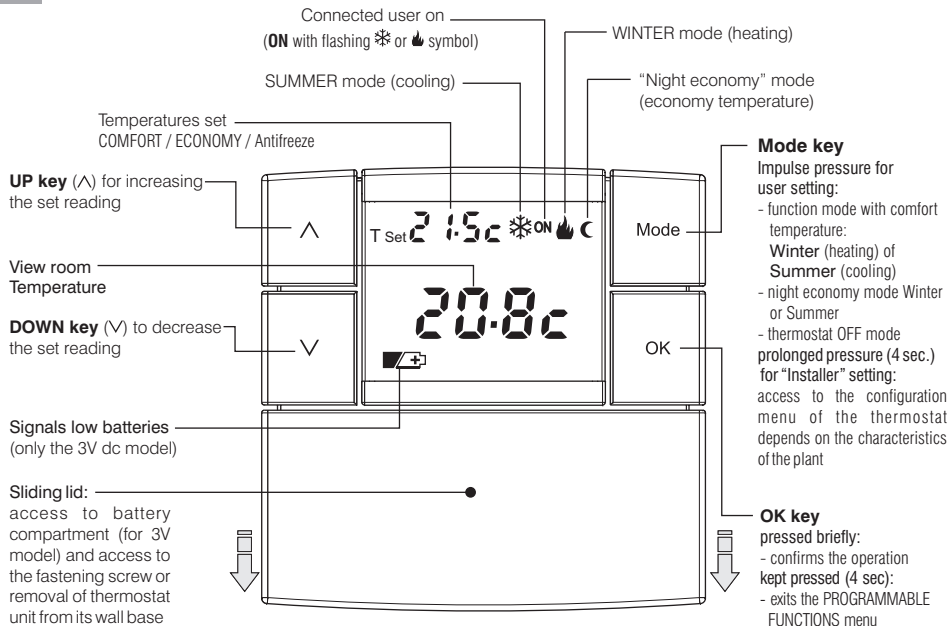

INSTALLATION

EN

EXAMPLE OF INSTALLATION

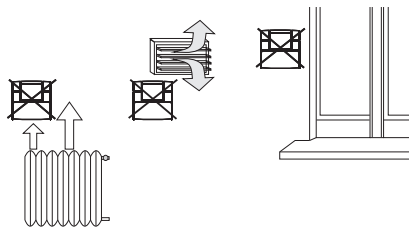
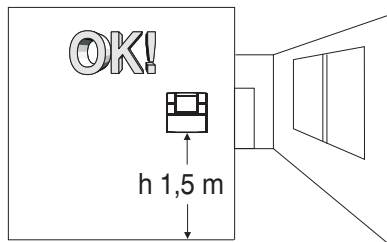

It is preferable to install the thermostat at $1.50 \div 1.60$ m from the floor, far from heat sources, air vents, doors or windows and whatever might influence its function.

DIMENSIONS

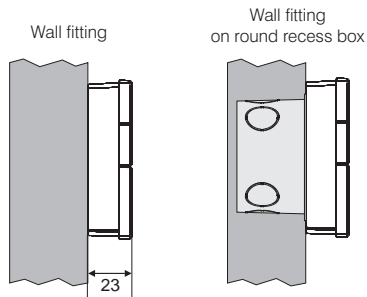
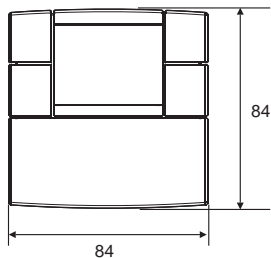

PRELIMINARY OPERATIONS

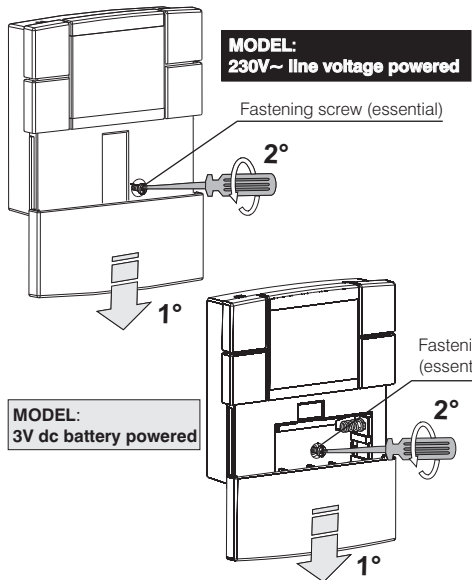

After loosening the screw, separate the thermostat from its base by levering with the screwdriver in the special slot in the lower part of the device.

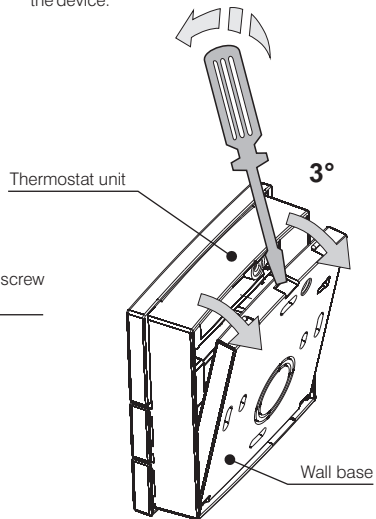

INSTALLATION

EN

WALL BASE AND TERMINALS

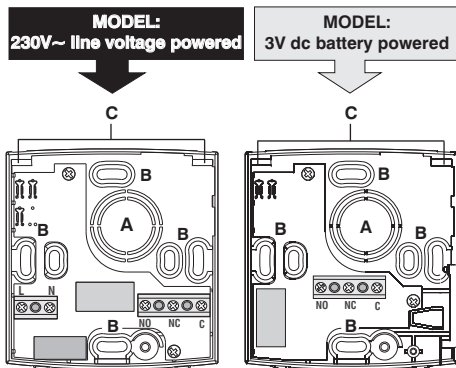

- A - Wire passage from:**
Round recess box or corrugated tube
- B - Base fixing holes:**
for fitting on the wall or round recess box
- C - Slot for hooking thermostat**

ELECTRIC CONNECTIONS

Disconnect 230V~ line voltage

Connect 230V~ line voltage power supply to the terminals:

L = Line

N = Neutral



Only for the 230V~ line voltage powered model

Connect the device to the terminals:

NO = contact normally open

NC = contact normally closed

C = common

Examples of electrical connections

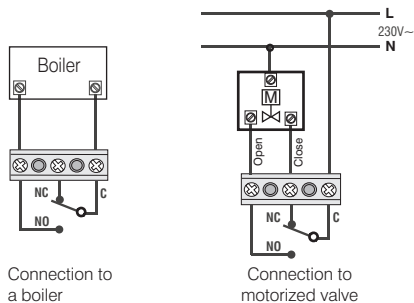

FIXING AND REMOVING THE THERMOSTAT

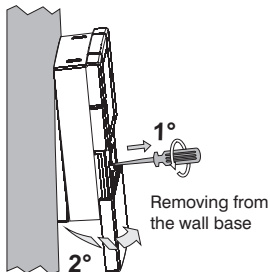
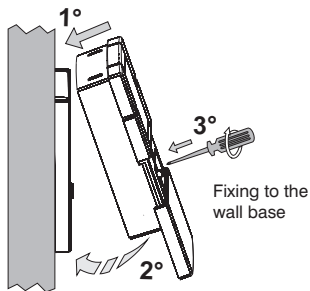

ONLY IN THE BATTERY-POWERED MODEL (3VDC)

FITTING OR REPLACING BATTERIES

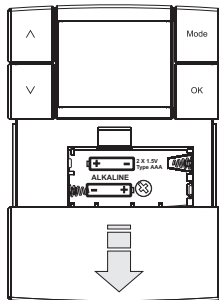

Fit or replace 2 minitilo 1.5V batteries type AAA-LR03 paying attention to the polarity.

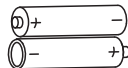

Use higher quality alkaline batteries (*Duracell* or *Energizer* batteries recommended).



Dispose of the old batteries in the special containers and anyway according to the environment protection laws





Attention: Battery life may be more than 2 years. However, it is recommended to replace them at least every 24 months to avoid them running out when you are away (e.g. Christmas holidays, etc.)

USER INSTRUCTIONS

EN

FUNCTION MODES

This thermostat has 5 function modes:

 WINTER = heating (by default) with COMFORT temperature
 Winter night economy = heating with ECONOMY temperature (economy)
OFF Thermostat off - In <i>heating mode</i> : antifreeze temperature mode is activated (if not excluded during setting) - In <i>cooling mode</i> : the system is completely deactivated
 SUMMER = cooling With COMFORT temperature
 Summer night economy = cooling with ECONOMY temperature (economy)

CHANGING FUNCTION MODE

Changing from COMFORT temperature to ECONOMY temperature and viceversa

Press **Mode** once. The symbol and the set temperature will start flashing; press **OK** within 5 seconds to confirm.

Changing from NORMAL FUNCTION to OFF

Press **Mode** twice. The word OFF and the set antifreeze temperature will start flashing; press **OK** within 5 seconds to confirm.

Changing from WINTER to SUMMER and viceversa

Press **Mode** 3 times. The symbol and the set temperature will start flashing; press **OK** within 5 seconds to confirm.

Changing from OFF to NORMAL FUNCTION

Press **Mode** once to return to the previous function mode.

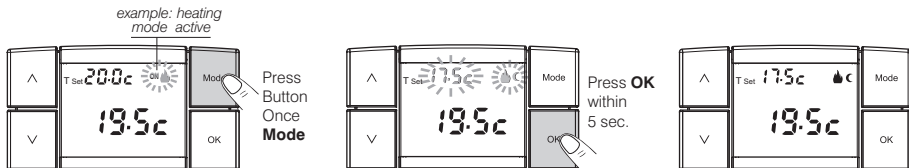

The figure above shows how to switch from WINTER mode with COMFORT temperature to ECONOMY temperature

CHANGE T set TEMPERATURE DEFAULT

From the current mode it is possible to change the setting of the T Set temperature by directly pressing the \wedge or \vee key, the new setting will be instantly stored.

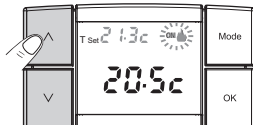

Note: every time a \wedge or \vee key is pressed a variation of 0.1 degrees is set; a faster flow of readings is achieved by holding the key pressed.

Note: The maximum and minimum temperature settings can be blocked (refer to the PROGRAMMABLE FUNCTIONS chapter).

Or:

Press one or more times the **Mode** key until the required function mode is displayed. within 5 seconds, press the \wedge key to increase the T Set reading or the \vee key to reduce it.

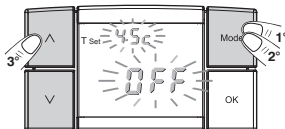

After 5 seconds from pressing a key the thermostat will regain the previous function





Note: if the antifreeze temperature is deselected (refer to the PROGRAMMABLE FUNCTIONS chapter) the user cannot change the anti-freeze temperature setting.

IMPORTANT: the thermostat temperature can be set from +5 °C to 37,7 °C (+41,0 °F ÷ +99,9 °F) with temperature readings which satisfy the following conditions:

Winter: "Comfort" temperature setting higher or the same as the winter economy temperature

Summer: "Comfort" temperature setting lower or the same as summer economy temperature.

The T set temperature manufacturer's default are the following:

	Winter Mode (heating): "Comfort" temperature 20,0 °C / 68,0 °F Boiler functioning on room temperature less than 20,0 °C / 68,0 °F
	Night economy winter: "Economy" temperature 17,5 °C / 63,5 °F Boiler functioning on room temperature less than 17,5 °C / 63,5 °F
	Summer mode (cooling): "Comfort" temperature 25,0 °C / 77,0 °F Air conditioner functioning on room temperature in excess of 25,0 °C / 77,0 °F
	Night economy summer: "Economy" temperature 28,0 °C / 82,4 °F Air conditioner functioning on room temperature in excess of 28,0 °C / 82,4 °F
OFF	Thermostat off (Anti-freeze mode) Anti-freeze temperature 4.0 °C / 39.2 °F (adjustable or excludable) - Boiler functioning on room temperature less than 4,0 °C / 39,2 °F - Air conditioning off

USER INSTRUCTIONS

EN

ONLY in the BATTERY-POWERED MODEL (3Vdc)

BATTERIES LOW OR FLAT SIGNAL

the flashing of the  symbol indicates that the batteries are low, from this moment on there are aprox. 30 days time to replace the batteries.

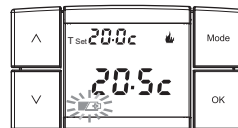

If the low batteries are not replaced within the declared time, the display will turn off leaving only a fixed  symbol.

Every heat regulation is suspended and all settings are stored to be reactivated once batteries have been replaced.

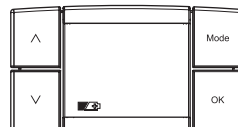

ONLY In the 230V ac POWERED MODEL

ABSENCE OF LINE POWER SUPPLY

In case of absence of power supply the thermostat display switches off completely deactivating heat regulation and saving and storing all settings effected, when the power supply resumes, the display switches on again and the device returns to its normal function.

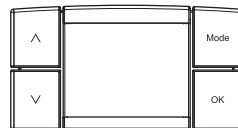

ACCESS TO PROGRAMMING

It is preferable that programming is accessed by the **installer or expert user** since changing some of the default settings could compromise the correct function of the installation.

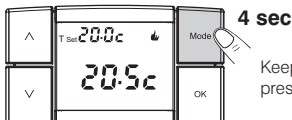

Keep the **Mode** key pressed for 4 seconds.

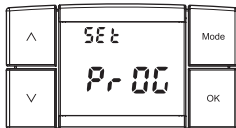

SET PROG. will appear on the display for a few seconds.

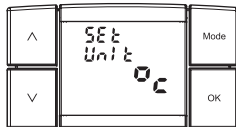

Then, the thermostat displays the measure unit set page.

In the program menu you access the various functions impulse pressing the **Mode** key, these being in sequence:

- Set scale of temperatures (°C or °F).
- Adjust measured room temperature (OFFSET).
- Block temperature set.
- Select temperature regulation mode: (DIFFERENTIAL ON/OFF or PROPORTIONAL).
- Change hysteresis set readings (Differential on/off).
- Change set time cycle (Proportional).
- Adjust or Exclude set antifreeze temperature.



Press **Mode** key one or more times to pass from one function to another.

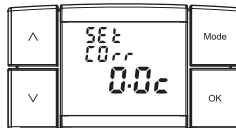

IMPORTANT: to exit the Programs menu including any new settings, confirm by pressing OK as follows: **Press OK for 4 seconds or wait 60 seconds (time-out);** the thermostat returns to normal operation.

SETTING OF THE TEMPERATURE SCALE

The thermostat is preset in production for viewing the temperatures in centigrades (Celsius), it is possible however to change to the Fahrenheit scale or viceversa with the following procedure:

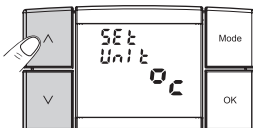

Press the \wedge or \vee key to change the current setting.

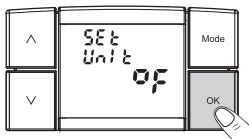

Press the **OK** key to save and move to the following setting or keep it pressed for at least 4 seconds to save the new setting and exit the program menu.

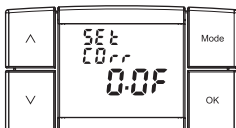

ADJUSTMENT OF ROOM TEMPERATURE READING

If for any reason the thermostat is installed in a position for which the measured temperature might be influenced (eg. an external wall which in the winter is on average colder than the rest of the house) it is possible to set an Offset (adjustment reading) of the measured temperature, the adjustment which can be set is from -2°C to $+2^{\circ}\text{C}$ or from -3.6 to $+3.6^{\circ}\text{F}$.

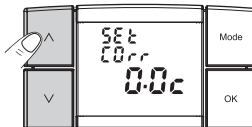

Press the \wedge or \vee key to change current Setting.

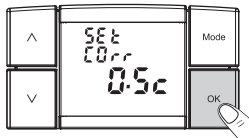

Press the **OK** key to save and move on to the following setting or keep it pressed for at least 4 seconds to save the new setting and exit the program menu.

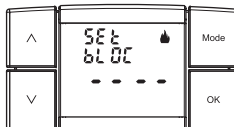

BLOCK MAX TEMPERATURE SETTING (winter) and MIN TEMPERATURE (summer)

In particular cases of thermostat installation, eg. In public buildings, hotels etc. it could be useful to limit the temperature set to comfort in order to avoid erroneous settings by non authorized personnel.

It is therefore possible to limit the maximum temperature settings if the thermostat is in 🔥 **Winter** mode (heating) or limit the minimum temperature setting of the thermostat is in ❄️ **Summer** mode (cooling).

In the default configuration no block has been set.

Example: block maximum Comfort temperature Winter mode (heating)

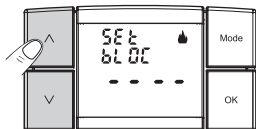

Press the **^** or **v** key to set the maximum temperature block reading.

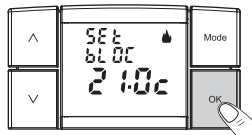

Press the **OK** key to save and pass on to the the ❄️ **Cooling** block setting or keep it pressed for at least 4 seconds to save the new setting and exit program menu.

Example: block minimum Comfort temperature for Summer mode (cooling)

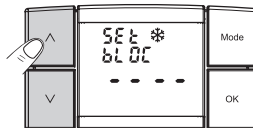

Press the **^** or **v** key to set the minimum temperature block reading.

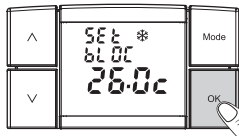

Press the **OK** key to save and pass on to the subsequent setting or keep pressed for at least 4 seconds to save the new setting and exit program menu.

Note: any previously blocked settings are cancelled by setting - - - -

TEMPERATURE REGULATION

The thermostat has been manufactured to work in **differential mod (ON/OFF)** with thermal differential reading (**hysteresis**) preset at **0.5 °C** (setting from 0,2 °C to 1,2 °C).

The hysteresis reading must be set on the basis of the thermal inertia of the system; a low reading is advisable for systems with radiators (eg, in cast iron) and a high reading for fan coil systems.

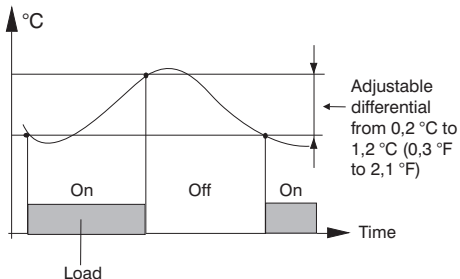

As opposed to the differential, the temperature can be adjusted **PROPORTIONALLY (PROP)** setting cycles from 7 to 20 minutes (default 10 minutes)

This system maintains the desired temperature more stable, whilst increasing the user's comfort sensation and saving on energy consumption

Setting example:

t set = 20 °C - Cycle = 10 min

t = 20,5 °C	Always off
t = 20,4 °C	Use 1 min ON - 9 min OFF
t = 20,3 °C	Use 2 min ON - 8 min OFF
t = 20,2 °C	Use 3 min ON - 7 min OFF
t = 20,1 °C	Use 4 min ON - 6 min OFF
t = 20,0 °C	Use 5 min ON - 5 min OFF
t = 19,9 °C	Use 6 min ON - 4 min OFF
t = 19,8 °C	Use 7 min ON - 3 min OFF
t = 19,7 °C	Use 8 min ON - 2 min OFF
t = 19,6 °C	Use 9 min ON - 1 min OFF
t = 19,5 °C	Always on

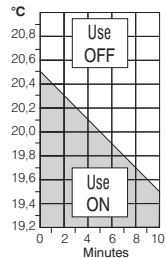

It is advisable to set a long cycle in systems with high thermal inertia (cast iron radiators, floor heating systems) and a short cycle in systems with low thermal inertia (fan coil).

Choose the temperature adjustment method and set the relative values in accordance with the characteristics of your system as shown in the following paragraphs.

SELECT TEMPERATURE ADJUSTMENT MODES (DIFFERENTIAL ON/OFF or PROPORTIONAL)

This procedure enables the selection of the temperature adjustment modes between the Differential **ON:OFF** (manufacturer's default) and Proportional **PROP**.

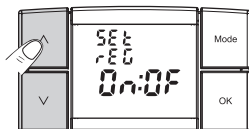

Press the \wedge or \vee key to set the required temperature adjustment mode.

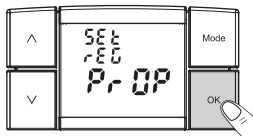

Press the **OK** key to save and pass on to the subsequent setting or keep pressed for at least 4 seconds to save the new setting and exit program menu.

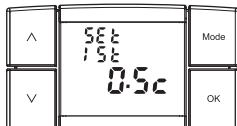

SETTING OF THE HYSTERESIS

The hysteresis reading in the **ON:OFF** adjustment mode must be set on the basis of the thermal inertia of the system; a low reading is advisable for systems with radiators (eg, in cast iron) and a high reading for fan coil systems. The readings which can be set from 0,2 °C to 1,2 °C (0,3 °F to 2,1 °F); the default reading is 0,5 °C (0,9 °F).

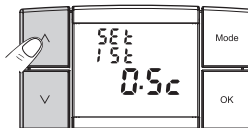

Press the \wedge or \vee key to set the required hysteresis reading.

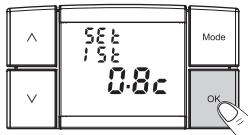

Press the **OK** key to save and pass on to the subsequent setting or keep pressed for at least 4 seconds to save the new setting and exit program menu.

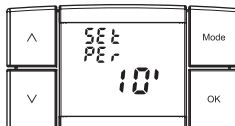

DURATION OF THE PROPORTIONAL CYCLE

The duration of the control cycle for the **PROP** mode can be set from **7 to 20** minutes; a long cycle is advisable for systems with high thermal inertia (cast iron radiators, floor heating systems) and a short cycle for systems with low thermal inertia (fan coil). The default setting is **10** minutes.

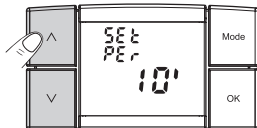

Press the **^** or **v** key to set the duration of The proportional control cycle.

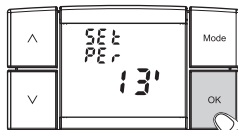

Press the **OK** key to save and pass on to the subsequent setting or keep pressed for at least 4 seconds to save the new setting and exit program menu.

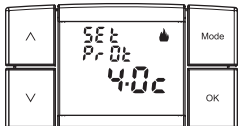

ADJUST OR EXCLUDE ANTIFREEZE PROTECTION

When the thermostat is **OFF**, it is programmed to protect the system in case of frost when the temperature goes below +4.0 °C (+39.2 °F); thus setting is adjustable from +4.0 °C to +12.0 °C (+39.2 °F ÷ +53.6 °F).

It is possible to exclude this function.

In this case the system will be exposed to eventual damage caused by frost.

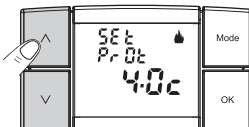

Press the **^** or **v** key to set the required antifreeze temperature reading.

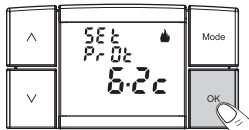

Press the **OK** key to save and return to the °C/°F scale setting or keep pressed for at least 4 seconds to save the new setting and exit program menu.

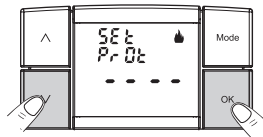

If instead the exclusion of the antifreeze protection is required, press the **v** key until the display shows **----** and confirm by pressing **OK**, as explained above.

RESET

Resetting should be done by the installer or expert user as with this operation all the settings and programming previously defined according to the type of installation will be lost.

Once the reset operation is done, the thermostat restores all the default settings provided by the manufacturer.

Press the 4 buttons of the thermostat simultaneously for at least 4 seconds.

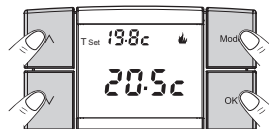

All the display segments switch on for a few seconds.

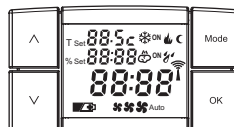

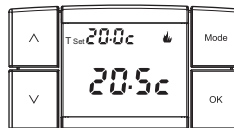

The thermostat resumes its function in Heating mode (Winter) restoring all the default settings provided by the manufacturer.



EVENTUAL FAULTS AND SOLUTIONS

EN

FAULT	CAUSE	SOLUTION
The display of the thermostat is switched off. <i>(3V dc model)</i>	Batteries not fitted Battery polarity error Flat batteries	Check that the batteries have been fitted Check the correct polarity of the batteries
The display of the thermostat is switched off. <i>(230V ac model)</i>	No power supply	Check that the switch or protection differential isn't on OFF
The  symbol on the display start flashing	The batteries are about to run out	Replace the batteries within 30 days
The display shows only the fixed  symbol	The batteries are flat	Replace batteries
The thermostat works but the system is not being activated	There is no power supply to the system The thermostat is not connected properly	Check that the switch or protection differential isn't on OFF Contact the installer
Temperature varies excessively between hot and cold	The thermostat is not correctly set for the type of system	Contact the installer
In the OFF mode, the anti-freeze temperature setting is not displayed	The anti-freeze temperature has been excluded	Set the anti-freeze temperature by following the guidelines given in the PROGRAMMABLE FUNCTIONS chapter